

Environmentally Sealed

Weather-Pack	22
Metri-Pack	25
TE Superseal	32
TE AMPSEAL 16	38
TE AMPSEAL	40
M12 Network	42
DIN Connectors	43
Schlemmer – Conduit Sealed	44
Schlemmer – Contact Sealed	46

Environmentally Sealed

Weather-Pack

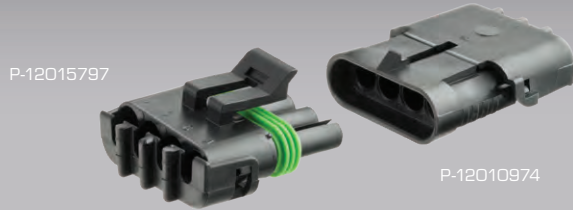

- Ideal for applications requiring protection from environmental hazards.
- Keyed for faultless connector mating.
- Hinged cover maximises terminal retention.
- Dual locking tabs on contacts.
- Made in North America.



Made in North America

Contact Rating :
Contacts :
Seal :
Housing :
Approvals :
Operating Temperature :

20A Max.
 Tin-plated Brass
 Silicone
 PA6
 ELV, RoHS
 -40°C to 125°C

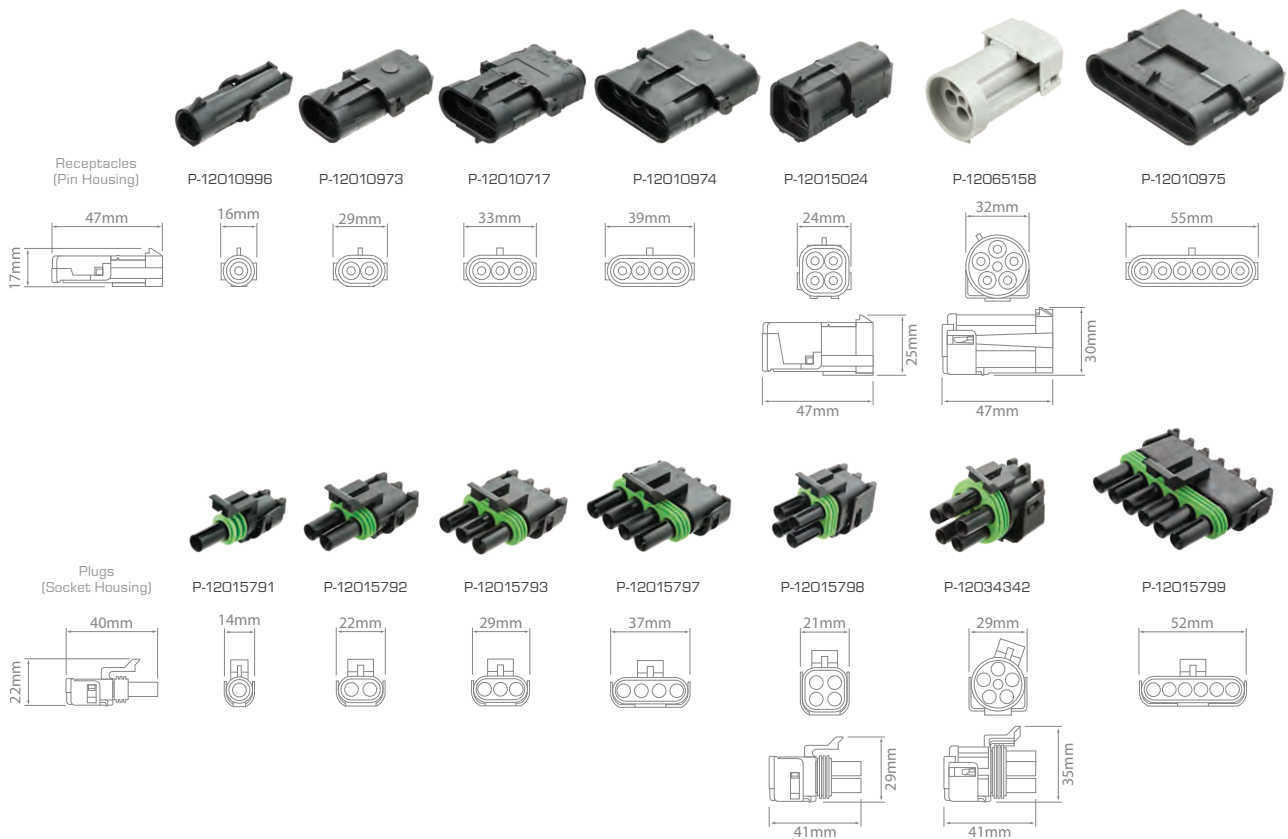

Weather-Pack – Connectors

1 Cavity	2 Cavities	3 Cavities	Receptacles 4 Cavities (1x4)	4 Cavities (2x2)	5 Cavities	6 Cavities
P-12010996/10	P-12010973/10	P-12010717/10	P-12010974/10	P-12015024/10	P-12065158/10	P-12010975/10
1 Cavity	2 Cavities	3 Cavities	Plugs 4 Cavities (1x4)	4 Cavities (2x2)	5 Cavities	6 Cavities
P-12015791/10	P-12015792/10	P-12015793/10	P-12015797/10	P-12015798/10	P-12034342/10	P-12015799/10

Supplied in packs of 10.
 Bulk stock also available in various quantities.



Environmentally Sealed



Weather-Pack – Kits

1 Circuit

P-WP1/2

- 2 x 1 Circuit Receptacle (12010996)
- 2 x 1 Circuit Plug (12015791)
- 2 x Contact – Socket (12124580)
- 2 x Contact – Pin (12124582)
- 8 x Seal (15324982)

4 Circuit (1x4)

P-WP4/2

- 2 x 4 Circuit Receptacle (12010974)
- 2 x 4 Circuit Plug (12015797)
- 8 x Contact – Socket (12124580)
- 8 x Contact – Pin (12124582)
- 16 x Seal (15324982)

6 Circuit

P-WP6/2

- 2 x 6 Circuit Receptacle (12010975)
- 2 x 6 Circuit Plug (12015799)
- 12 x Contact – Socket (12124580)
- 12 x Contact – Pin (12124582)
- 24 x Seal (15324982)

2 Circuit

P-WP2/2

- 2 x 2 Circuit Receptacle (12010973)
- 2 x 2 Circuit Plug (12015792)
- 4 x Contact – Socket (12124580)
- 4 x Contact – Pin (12124582)
- 8 x Seal (15324982)

4 Circuit (2x2)

P-WP4S/2

- 2 x 4 Circuit Receptacle (12015024)
- 2 x 4 Circuit Plug (12015798)
- 8 x Contact – Socket (12124580)
- 8 x Contact – Pin (12124582)
- 16 x Seal (15324982)

3 Circuit

P-WP3/2

- 2 x 3 Circuit Receptacle (12010717)
- 2 x 3 Circuit Plug (12015793)
- 6 x Contact – Socket (12124580)
- 6 x Contact – Pin (12124582)
- 12 x Seal (15324982)

5 Circuit

P-WP5/2

- 2 x 5 Circuit Receptacle (12034342)
- 2 x 5 Circuit Plug (12065158)
- 10 x Contact – Socket (12124580)
- 10 x Contact – Pin (12124582)
- 20 x Seal (15324982)

For tools refer to page 30-31



Weather-Pack – Assortment Kit

Part No.	Description	Kit Contents			
P-WP-1	247 Piece	Receptacles: 4 x 1 Circuit (12010996) 4 x 2 Circuit (12010973) 3 x 3 Circuit (12010717) 3 x 4 Circuit (12010974) 2 x 6 Circuit (12010975)	Plugs: 4 x 1 Circuit (12015791) 4 x 2 Circuit (12015792) 3 x 3 Circuit (12015793) 3 x 4 Circuit (12015797) 2 x 6 Circuit (12015799)	Contacts: 50 x Sockets (12124580) 50 x Pins (12124582)	Misc: 4 x Fuse Holder (WSBFH) 1 x Extraction Tool (12014012)
		Seals & Cavity Plugs: 100 x Seals (15324982) 10 x Cavity Plug (12010300)			



Environmentally Sealed

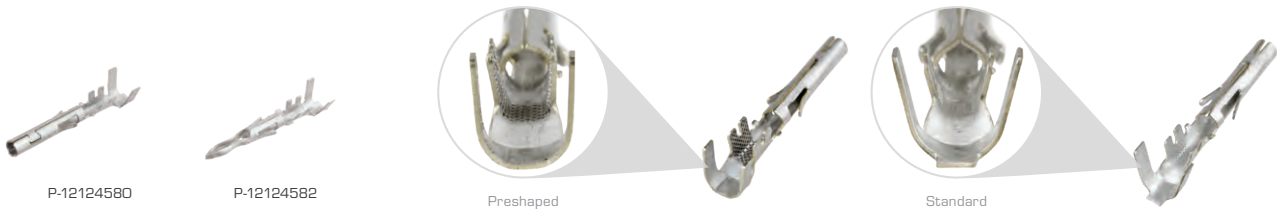

Weather-Pack – Contacts

Pack Qty – 100	Pack Qty – 2200 (Reel)	Type	Wire Size (mm ²)	Max. Cable O.D. (mm)	Description
P-12089188/100	P-12089188-BULK	Socket	0.5 – 0.8	3.11	Standard
P-12089040/100	P-12089040-BULK	Pin	0.5 – 0.8	3.11	Standard
P-12124580/100	P-12124580-BULK	Socket	1.0 – 2.0	3.96	Standard
P-12124582/100	P-12124582-BULK	Pin	1.0 – 2.0	3.96	Standard
PF-12124580/100	—	Socket	1.0 – 2.0	3.96	Preshaped
PF-12124582/100	—	Pin	1.0 – 2.0	3.96	Preshaped
P-12124581/100	P-12124581-BULK	Socket	2.0 – 3.0	3.96	Standard
P-12124587/100	P-12124587-BULK	Pin	2.0 – 3.0	3.96	Standard
PF-12124581/100	—	Socket	2.0 – 3.0	3.96	Preshaped
PF-12124587/100	—	Pin	2.0 – 3.0	3.96	Preshaped

For tools refer to page 30-31



P-15324981



P-15324980



P-15324982



P-15324983



P-12010300

Weather-Pack – Seals & Cavity Plug

Pack Qty – 100	Bulk Pack	Bulk Qty	Description	Cable O.D. Range (mm)	Connector Cavity Ø (mm)	Colour
P-15324981/100	P-15324981-BULK	7000	Seal	4.30 – 3.45	6.7	Blue
P-15324980/100	P-15324980-BULK	7000	Seal	3.49 – 2.81	6.7	Grey
P-15324982/100	P-15324982-BULK	5000	Seal	2.85 – 2.03	6.7	Green
P-15324983/100	P-15324983-BULK	5000	Seal	1.70 – 1.29	6.7	Burgundy
P-12010300/100	P-12010300-BULK	3500	Cavity Plug	—	6.7	Green

Environmentally Sealed

Metri-Pack

- In-line connections for vehicle underhood applications.
- Meet or exceeds the requirements for most marine appliance and industrial control applications.
- Triple-rib peripheral silicone seals.
- Suitable for critical, low-energy electronic applications requiring protection from environmental hazards.
- Contact retainers ensure optimal device connection.
- Low energy, low voltage capability.
- Excellent resistance to temperature, chemicals and abrasion.
- Made in North America.

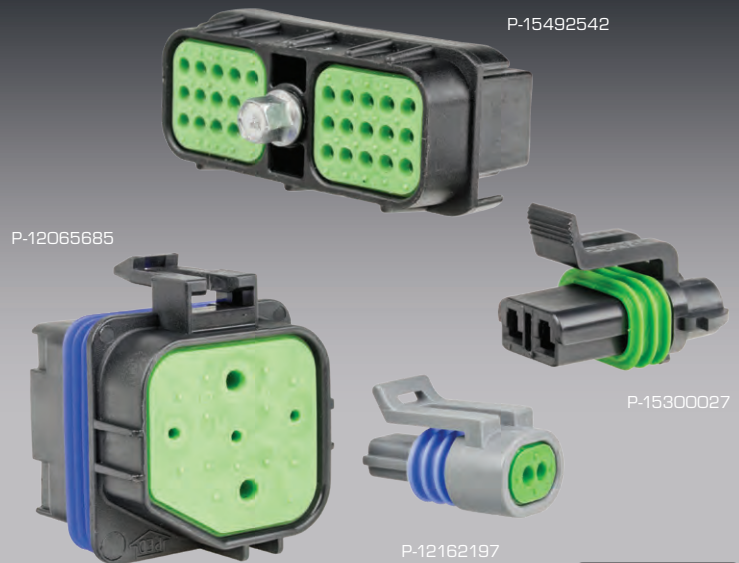

Series :	150	280	630
Contact Rating :	14A	30A	46A
Blade Width :	1.5mm	2.8mm	6.3mm
Operating Temperature :		-40°C to 125°C	

Made in North America



Metri-Pack – 150 Series – Connectors

Part No.	Type	Cavities	Contacts (1.5mm)	Body	Colour	Seal (1.5mm)	Retainer	Pack Qty
P-12052643/10	Plug	2	Receptacles	Red	Grey	P-15336530/10	10	
P-12052641/10	Plug	2	Receptacles	Black	Grey	P-15336530/10	10	
P-12162000/10	Receptacle	2	Tabs	Black	—	P-15336530/10	10	
P-12110293/10	Plug	3	Receptacles	Black	Purple	P-12052845/10	10	
P-12129615/10	Receptacle	3	Tabs	Black	—	P-12052845/10	10	
P-12162144/10	Plug	4	Receptacles	Black	Amber	P-12047948/10	10	
P-12162102/10	Receptacle	4	Tabs	Black	—	P-12047948/10	10	
P-12052848/10	Plug	6	Receptacles	Black	Blue	P-12052850/10	10	
P-12124107/10	Receptacle	6	Tabs	Black	—	P-12052850/10	10	
P-12047937/5	Plug	8	Receptacles	Black	Amber	P-12066304/5	5	
P-12047931/5	Receptacle	8	Tabs	Black	—	P-12066304/5	5	
P-12065425/5	Plug	10	Receptacles	Black	Green	P-12124264/5	5	
P-12045808/5	Receptacle	10	Tabs	Black	—	P-12124264/5	5	



Environmentally Sealed



Metri-Pack – 150 Series – Connectors – Device Connections

Part No.	Pack Qty – 10	Type	Cavities	Contacts (1.5mm)	Colour Body Seal	Retainer	Typical Application
P-12065298	P-12065298/10	Plug	4	Receptacles	Black Green	P-12066176/10	Switch

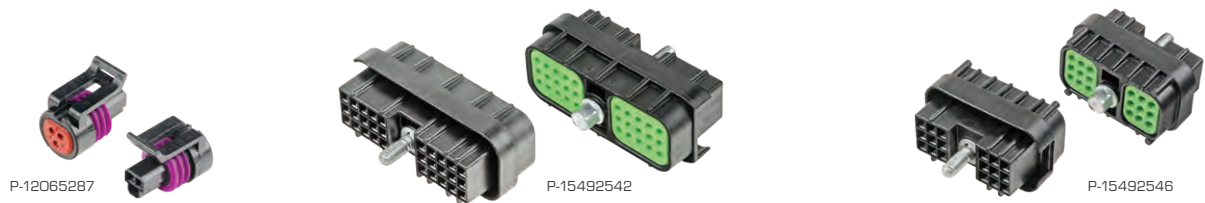

Metri-Pack – 150 Series – Connectors – Pull-to-Seat

Part No.	Pack Qty – 10	Type	Cavities	Contacts (1.5mm)	Cable O.D. Range (mm)	Body	Colour Connector Seal	Cable Seal
P-12065287	P-12065287/10	Plug	3	Receptacles	1.65 – 2.15	Black	Purple	Red
P-15492542	—	Plug	30	Receptacles	2.0 – 2.4	Black	—	Green
P-15492546	—	Plug	18	Receptacles	2.0 – 2.4	Black	—	Green



For tools refer to page 30–31

Metri-Pack – 150 Series – Contacts

Pack Qty – 100	Pack Qty – Reel	Reel Qty	Type (1.5mm)	Wire Size (mm ²)	Cable O.D. Range (mm)	Description
P-12048074/100	P-12048074-BULK	3000	Receptacle	0.8 – 1.0	2.03 – 2.40	
P-12045773/100	P-12045773-BULK	3000	Tab	0.8 – 1.0	2.03 – 2.40	
P-12103881/100	P-12103881-BULK	5000	Receptacle	0.8 – 1.0	2.03 – 2.40	Pull-to-Seat



Metri-Pack – 150 Series – Seals & Cavity Plug

Pack Qty – 100	Bulk Pack	Bulk Qty	Description	Cable O.D. Range (mm)	Connector Cavity Ø (mm)	Colour
P-15324974/100	P-15324974-BULK	10,000	Seal	1.2 – 1.7	5.2	Blue
P-15324976/100	P-15324976-BULK	10,000	Seal	1.6 – 2.15	5.2	White
P-15324973/100	P-15324973-BULK	10,000	Seal	2.03 – 2.85	5.2	Red
P-12059168/100	P-12059168-BULK	7500	Cavity Plug	—	5.2	Burgundy

Environmentally Sealed

Contact & Housing Keying

150.2 Series Connectors feature contact and connector keying making it impossible to mate with a non-corresponding contact or connector.



P-12162197

Housing colour indicates the housing keying



Contact keying

P-12124075/100

Only contacts with a keying tab on the matching side will fit into the 150.2 Series Connectors.



P-12162193



P-12162197



P-12162182



P-12162279



P-12162833



P-12162188



P-12162190



P-12162826

Metri-Pack – 150.2 Series – Connectors – Pull-to-Seat

Part No.	Pack Qty – 10	Type	Cavities	Contacts (1.5mm)	Cable O.D. Range (mm)	Body	Colour Connector Seal	Cable Seal
P-12162193	P-12162193/10	Plug	2	Receptacles	2.0 – 2.66	Black	Blue	Green
P-12162197	P-12162197/10	Plug	2	Receptacles	2.0 – 2.66	Grey	Blue	Green
P-12162182	P-12162182/10	Plug	3	Receptacles	2.0 – 2.66	Black	Green	Green
P-12162279	P-12162279/10	Plug	3	Receptacles	1.65 – 2.15	Grey	Green	Green
P-12162833	P-12162833/10	Plug	4	Receptacles	2.0 – 2.66	Grey	Blue	Green
P-12162188	P-12162188/10	Plug	4	Receptacles	2.0 – 2.66	Black	Blue	Green
P-12162190	P-12162190/10	Plug	4	Receptacles	1.47 – 1.85	Black	Blue	Orange
P-12162826	P-12162826/10	Plug	5	Receptacles	1.65 – 2.15	Black	Green	Tan

For tools refer to page 30–31

Contact keying



P-12124075

Metri-Pack – 150.2 Series – Contacts – Pull-to-Seat

Pack Qty – 100	Pack Qty – 3500 (Reel)	Type (1.5mm)	Wire Size (mm ²)	Cable O.D. Range (mm)	Keying
P-12124075/100	P-12124075-BULK	Receptacle	0.8 – 1.0	2.03 – 2.40	Yes



Environmentally Sealed



Metri-Pack – 280 Series – Connectors

Pack Qty – 10	Type	Cavities	Contacts (2.8mm)	Colour		Retainer	Pack Qty
				Body	Seal		
P-12065172/10	Plug	1	Receptacles	Black	Tan	P-12065249/10	10
P-12065171/10	Receptacle	1	Tabs	Black	NA	P-12065249/10	10
P-15300027/10	Plug	2	Receptacles	Black	Green	P-15300014/10	10
P-15300002/10	Receptacle	2	Tabs	Black	NA	P-15300014/10	10
P-12040977/10	Plug	3	Receptacles	Black	Tan12	P-12034145/10	10
P-15300003/10	Receptacle	3	Tabs	Black	NA	P-15300015/10	10
P-12129565/10	Plug	4	Receptacles	Grey	Green	P-15300016/10	10
P-12129600/10	Receptacle	4	Tabs	Grey	NA	P-15324063/10	10
P-12084891/10	Plug	5	Receptacles	Grey	Green	P-15324857/10	10
P-12186400/10	Receptacle	5	Tabs	Grey	NA	P-12084673/10	10



P-12077411



P-12129497

For tools refer to page 30–31

Metri-Pack – 280 Series – Contacts

Pack Qty – 100	Pack Qty – Reel	Reel Qty	Type (2.8mm)	Wire Size (mm ²)	Cable O.D. Range (mm)	Description
P-12077411/100	P-12077411-BULK	2300	Receptacle	0.5 – 1.25	2.03 – 3.12	
P-12048159/100	P-12048159-BULK	2200	Tab	0.5 – 0.8	2.03 – 3.12	
P-12129493/100	P-12129493-BULK	2300	Receptacle	2.0 – 3.0	2.45 – 3.80	
P-12129497/100	P-12129497-BULK	2000	Tab	2.0 – 3.0	2.45 – 3.80	
P-12077413/100	P-12077413-BULK	2000	Receptacle	3.0	3.49 – 3.65	
P-12048254/100	P-12048254-BULK	2000	Tab	3.0	3.49 – 3.65	
P-12129409/100	P-12129409-BULK	2000	Receptacle	1.0 – 2.0	2.48 – 3.05	Tangless



P-15324981



P-15324980



P-15324982



P-15324983



P-12010300

Metri-Pack – 280 Series – Seals & Cavity Plug

Pack Qty – 100	Pack Qty – Bulk	Bulk Qty	Description	Cable O.D. Range (mm)	Connector Cavity Ø (mm)	Colour
P-15324981/100	P-15324981-BULK	7000	Seal	4.30 – 3.45	6.7	Blue
P-15324980/100	P-15324980-BULK	7000	Seal	3.49 – 2.81	6.7	Grey
P-15324982/100	P-15324982-BULK	5000	Seal	2.85 – 2.03	6.7	Green
P-15324983/100	P-15324983-BULK	5000	Seal	1.70 – 1.29	6.7	Burgundy
P-12010300/100	P-12010300-BULK	3500	Cavity Plug	—	6.7	Green

Environmentally Sealed



Metri-Pack – 630 Series – Relay Base

Part No.	Pack Qty – 400	Description	Contact Type	Cavities	Contacts (6.3mm)
P-12065685	P-12065685-BULK	Weatherproof Mini Relay Base	Pull-to-Seat	5	Sockets



P-12066614



P-12033997



P-12015870



P-12015865

Metri-Pack – 630 Series – Contacts

Part No.	Pack Qty	Pack Qty – Reel	Reel Qty	Type (6.3mm)	Wire Size (mm ²)	Cable O.D. Range (mm)	Description
P-12066614/100	100	P-12066614-BULK	2000	Receptacle	1.0 – 2.0	3.14 – 3.97	Pull-to-Seat
P-12033997/100	100	P-12033997-BULK	1800	Receptacle	3.0	2.94 – 3.68	Pull-to-Seat
P-12015870/100 *	100	P-12015870-BULK *	2100	Receptacle	1.0 – 2.0	2.48 – 3.97	Push-to-Seat
P-12015865/10 *	10	—	—	Receptacle	1.0 – 2.0	2.48 – 3.97	Push-to-Seat

* Not for use with contact seals.

For tools refer to page 30–31



P-WSBFH

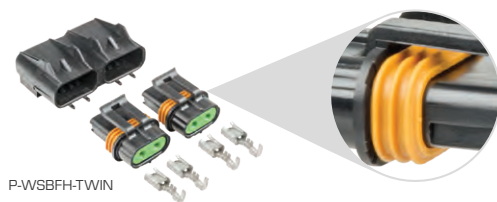

P-WSBFH-TWIN

Weatherproof seal



P-MSBFH

Metri-Pack – Blade Fuse Holders – Weatherproof Kits

Part No.	Housing Type	Fuse Type	Current Rating (A)	Kit Contents
P-WSBFH/5	Mountable	ATC	30	5 x Housing (12033731), 5 x Fuse Holder (12033769), 10 x Contacts (12066614)
P-WSBFH-TWIN	Double	ATC	30	1 x Double Housing (12059426), 2 x Fuse Holder (12033769), 4 x Contacts (12066614)
P-MSBFH/5	Mountable	ATM	20	5 x Housing (15300027C), 5 x Fuse Holder (15300027), 10 x Contacts (12129493), 10 x Seals (15324982), 5 x Retainers (15300014)



Environmentally Sealed



5 Piece Crimp Tool Set for Packard™ Contacts

Tool Set contains tools suitable for:

- AMP Superseals.
- Weather-Pack.
- Metri-Pack 150, 280, 480 & 630 series.
- Micro-Pack 064, 100 & 100W series.
- GT 150, 280, 630 series.
- And other brands including Molex, Yazaki, Sumitomo etc.

All housed in a handy storage tray.

Also included in the kit is a 32 page instruction manual detailing tool specifications as well as an OEM contact number/tool number matrix.

All tools in kit are premium quality – made in the USA.

Tools – IONNIC Crimper Set

Part No.	Description
HT-K2680	5 Piece crimping tool set for wide range of contacts, includes instruction manual Suits AMP Superseals, Weather-Pack and Metri-Pack contacts among others. For full list see above

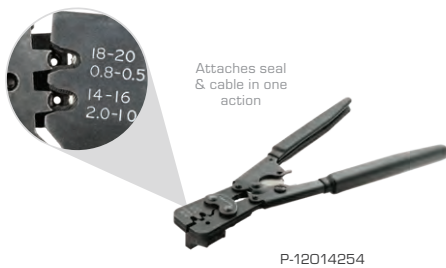

P-12014254



P-12071687

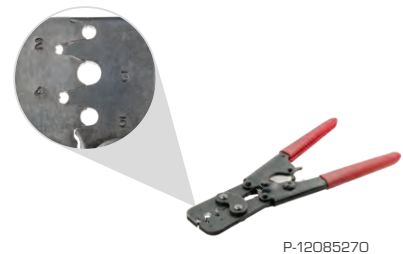

P-12085270

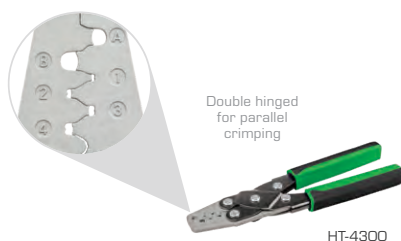

HT-4300



HT-4220

Tools – Crimpers

Part No.	Description	Suits	Contact Crimp Range (mm ²)
P-12014254	Ratcheting. Attaches seal & cable in one action	Weather-Pack	0.5-0.8, 1.0-2.0
P-12071687 NEW	480 & 630 Series	Weather-Pack & Metri-Pack	3.0-5.0
P-12085270	Ratcheting	Weather-Pack & Metri-Pack	0.5-0.8, 1.0-2.0
HT-4300	Parallel jaws	Weather-Pack & Metri-Pack 150 & 280 Series	0.35, 0.5-0.8, 1.0-2.0, 3.0
HT-4220	Parallel jaws	Non-insulated contacts	0.2-0.3, 0.3-0.5, 0.5-0.8, 0.8-1.3, 1.3-2.0

Environmentally Sealed

How to Crimp



Apply correct seal as per wire diameter.
Align seal with cable insulation.

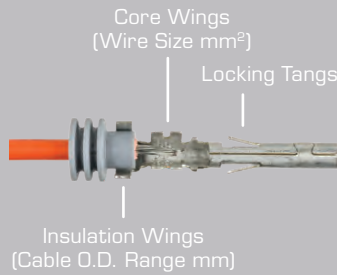

Position cable and seal so exposed wires are between the core wings, as shown above.



Crimp the core wings before insulation wings using the appropriate crimp tool.



P-12094429



P-12094430



P-12014012

Tools – Contact Removal

Part No.	Suits
P-12094429	Metri-Pack GT150, GT280, 150, 280, 630 Pull-to-Seat
P-12094430	Metri-Pack 280, 480, 630, 800 Series Pin Tangless
P-12014012	Weather-Pack

AWG to mm²

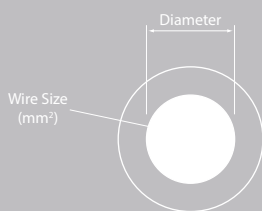

American Wire Gauge (AWG)	Diameter (mm)	Wire Size (mm ²)	American Wire Gauge (AWG)	Diameter (mm)	Wire Size (mm ²)
4	5.19	21.14	16	1.29	1.31
6	4.11	13.29	18	1.02	0.82
8	3.26	8.36	20	0.81	0.52
10	2.59	5.26	22	0.65	0.33
12	2.05	3.31	24	0.51	0.20
14	1.63	2.08			

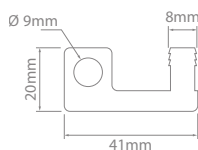

Accessories

Pack Qty – 10	Description	Suits
P-15495824/10	Receptacle mount	Most Weather-Pack and Metri-Pack 150 Series



Environmentally Sealed

TE Superseal



282088-1

282106-1

- Compact design.
- Secondary lock ensures contact retention.
- Environmentally sealed – IP67, when installed to manufacturer's specifications.
- Ideal for truck, bus, marine, agriculture and off-road vehicles.
- Available as receptacle or plug half kits.
- Made in North America.

IP67 Made in North America

Contact Rating :
Contacts :
Seal :
Housing :
Ingress Protection :

14A
 Tin-plated Copper
 Silicone
 Polyamide
 IP67

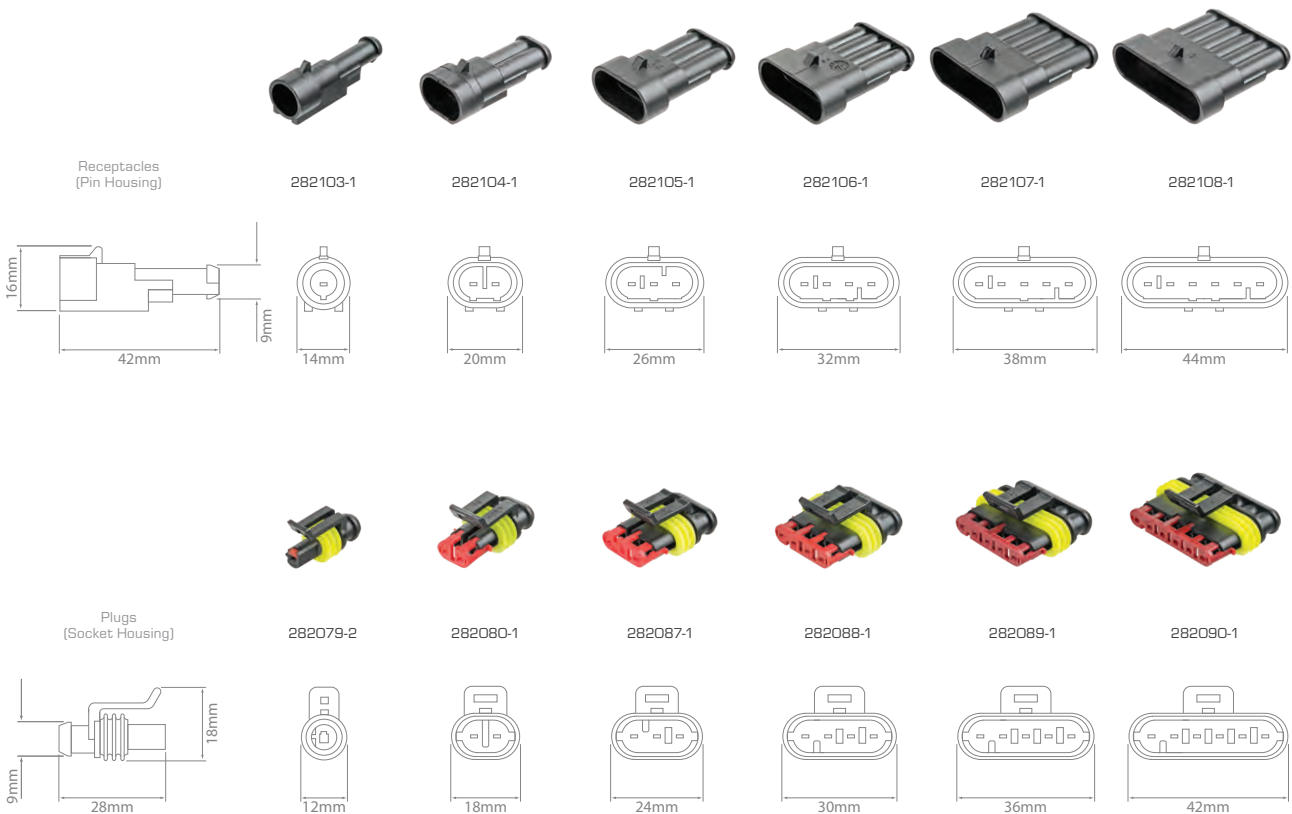

TE Superseal – Connectors

	1 Cavity	2 Cavity	3 Cavity	4 Cavity	5 Cavity	6 Cavity
Receptacles	282103-1/10	282104-1/10	282105-1/10	282106-1/10	282107-1/10	282108-1/10
Plugs	282079-2/10	282080-1/10	282087-1/10	282088-1/10	282089-1/10	282090-1/10

Supplied in packs of 10.



Environmentally Sealed



50125



50134

TE Superseal – Half Kits

1 Circuit – Receptacles

50123

1 x 1 Circuit Receptacle (282103-1)
1 x Pin (183024-1)
1 x Seal (281934-2)

2 Circuit – Receptacles

50125

1 x 2 Circuit Receptacle (282104-1)
2 x Pins (183024-1)
2 x Seals (281934-2)

3 Circuit – Receptacles

50127

1 x 3 Circuit Receptacle (282105-1)
3 x Pins (183024-1)
3 x Seals (281934-2)

4 Circuit – Receptacles

50129

1 x 4 Circuit Receptacle (282106-1)
4 x Pins (183024-1)
4 x Seals (281934-2)

5 Circuit – Receptacles

50131

1 x 5 Circuit Receptacle (282107-1)
5 x Pins (183024-1)
5 x Seals (281934-2)

6 Circuit – Receptacles

50133

1 x 6 Circuit Receptacle (282108-1)
6 x Pins (183024-1)
6 x Seals (281934-2)

1 Circuit – Plugs

50124

1 x 1 Circuit Plug (282079-2)
1 x Socket (183025-1)
1 x Seal (281934-2)

2 Circuit – Plugs

50126

1 x 2 Circuit Plug (282080-1)
2 x Sockets (183025-1)
2 x Seals (281934-2)

3 Circuit – Plugs

50128

1 x 3 Circuit Plug (282087-1)
3 x Sockets (183025-1)
3 x Seals (281934-2)

4 Circuit – Plugs

50130

1 x 4 Circuit Plug (282088-1)
4 x Sockets (183025-1)
4 x Seals (281934-2)

5 Circuit – Plugs

50132

1 x 5 Circuit Plug (282089-1)
5 x Sockets (183025-1)
5 x Seals (281934-2)

6 Circuit – Plugs

50134

1 x 6 Circuit Plug (282090-1)
6 x Sockets (183025-1)
6 x Seals (281934-2)



TE Superseal – Assortment Kit

Part No.	Description	Kit Contents
AMPKIT-1	154 Piece	<p>Receptacles:</p> <ul style="list-style-type: none"> 3 x 1 Circuit (282103-1) 3 x 2 Circuit (282104-1) 3 x 3 Circuit (282105-1) 2 x 4 Circuit (282106-1) 2 x 5 Circuit (282107-1) 1 x 6 Circuit (282108-1) <p>Plugs:</p> <ul style="list-style-type: none"> 3 x 1 Circuit (282079-2) 3 x 2 Circuit (282080-1) 3 x 3 Circuit (282087-1) 2 x 4 Circuit (282088-1) 2 x 5 Circuit (282089-1) 1 x 6 Circuit (282090-1) <p>Contacts & Seals:</p> <ul style="list-style-type: none"> 42 x Sockets (183025-1) 42 x Pins (183024-1) 42 x Seals (281934-2)



Environmentally Sealed



183024-1



183025-1

TE Superseal – Contacts

Pack Qty – 100	Type	Wire Size (mm ²)	Cable O.D. Range (mm)
183024-1/100	Pin	0.75 – 1.5	1.7 – 2.4
183025-1/100	Socket	0.75 – 1.5	1.7 – 2.4



281934-2



282081-1

TE Superseal – Seal & Cavity Plug

Pack Qty – 100	Pack Qty – 10	Description	Cable O.D. Range (mm)	Connector Cavity Ø (mm)	Colour
281934-2/100	—	Seal	1.7 – 2.4	5.7	Yellow
282081-1/100	282081-1/10	Cavity Plug	—	5.7	Red

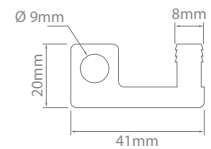

TE Superseal – Tool & Accessory

Part No.	Description	Contact Crimp Range (mm ²)
HT-4301	Parallel jaw	0.35–0.5, 0.75, 1.0, 1.5
P-15495824/10	Receptacle mount. Pack quantity 10	



1670916-KIT



TE MCON – 2 Circuit Kit NEW

Part No.	Description	Kit Contents
1670916-KIT	2 circuit MCON receptacle kit 1.2mm contacts	1 x 2 Circuit MCON Receptacle (1-1670916-1) 2 x Sockets (7-1452671-1) 2 x Seals (964972-1)

Environmentally Sealed



Seals & Cavity Plugs – Generic NEW

Pack Qty – 100	Description	Connector Cavity Ø (mm)	Cable O.D. Range (mm)	Colour
WS1009/100	Seal	5.2	1.2 – 1.7	Blue
WS1006/100	Seal	5.2	1.6 – 2.5	White
WS1007/100	Seal	5.2	2.2 – 2.85	Red
WS1001/100	Seal	8.5	0.9 – 1.5	Dark Yellow
WS1002/100	Seal	8.5	1.7 – 2.3	Blue
WS1003/100	Seal	8.5	2.3 – 2.9	Red
WS1005/100	Seal	8.5	3.0 – 3.9	Green
WS1014/100	Seal	6.7	1.29 – 1.7	Red
WS1013/100	Seal	6.7	2.03 – 2.85	Green
WS1011/100	Seal	6.7	2.1 – 3.49	Grey
WS1012/100	Seal	6.7	3.45 – 4.3	Blue
WS1008/100	Cavity Plug	5.2	–	Burgundy
WS1010/100	Cavity Plug	7.2	–	Green
WS1004/100	Cavity Plug	8.5	–	Black



Environmentally Sealed



NEW



Numbered handles



Contact Removal Tool Set **NEW**

Part No. HT-4306 Description 23 Piece Set

Tool Number	Type	Size		Application
1	Tube	4.3mm Inside Ø		BMW, Mercedes, Opel, VW/Audi
2	Tube	3.7mm Inside Ø		BMW, Jaguar, Mercedes, Porsche, Saab, Seat, Skoda
3	Tube	2.6mm Inside Ø		BMW, Mercedes, Opel, Porsche, VW/Audi
4	Flat Blade – Twin	1.6mm x 15mm		Ford
5	Flat Blade – Twin	1.55mm x 20mm		BMW, Ford, Mercedes, Opel, Porsche, Seat, Skoda, VW/Audi
6	Flat Blade – Twin	1.55mm x 17mm		BMW, Ford, Jaguar, Mercedes, Opel, Porsche, Saab, Seat, Skoda, VW/Audi
7	Flat Blade – Twin w. Angled Tips	1.6mm x 20mm		Mercedes
8	Flat Blade	1.8mm x 18mm		Ford, Jaguar, Mercedes, Opel, Porsche, VW/Audi
9	Square Blade	1mm x 18mm		Ford, Mercedes
10	Flat Blade	1.15mm x 18mm		Mercedes
11	Flat Blade – Twin	1.6mm 65mm		BMW, Ford, Jaguar, Mercedes, Opel, Porsche, Saab, Seat, Skoda, VW/Audi
12	Flat Blade – Twin w. Angled Tips	1.65mm x 23mm		Opel, Renault, Skoda, VW/Audi
13	Flat Blade	3mm x 18.5		Ford, Mercedes
14	Flat Blade – with Notch	1mm x 18mm		Ford, Jaguar, Porsche
15	Flat Blade – with U-Notch	1mm x 24mm		BMW, Ford, Mercedes, Opel, Seat, Skoda, VW/Audi
16	Flat Blade	1.8mm x 18mm		BMW, Ford, Jaguar, Mercedes, Opel, Porsche, VW/Audi
17	Flat Blade – Twin	1.6mm x 25mm		BMW
18	Flat Blade – Triple	1mm x 9mm		Mercedes
19	Pin Blade	0.9mm x 19mm		Citroen, Chrysler, Fiat, Ford, Honda, Mazda, Mercedes, Mitsubishi, Opel, Porsche, Renault, Seat, Toyota, VW/Audi
20	Flat Blade – Twin	1.6mm x 20mm		Ford
21	Flat Blade – Twin	0.9mm x 15mm		BMW, Ford, Jaguar, Mercedes, Opel, Porsche, Saab, Seat, Skoda, VW/Audi
22	Pick Blade	1mm x 19mm		Honda, Opel, Toyota, VW/Audi
23	Flat Blade – Twin	0.9mm x 13mm		Opel, VW/Audi

Newsletter

Receive the latest ionnic news and updates via email, sign up at ionnic.com/product-updates.html

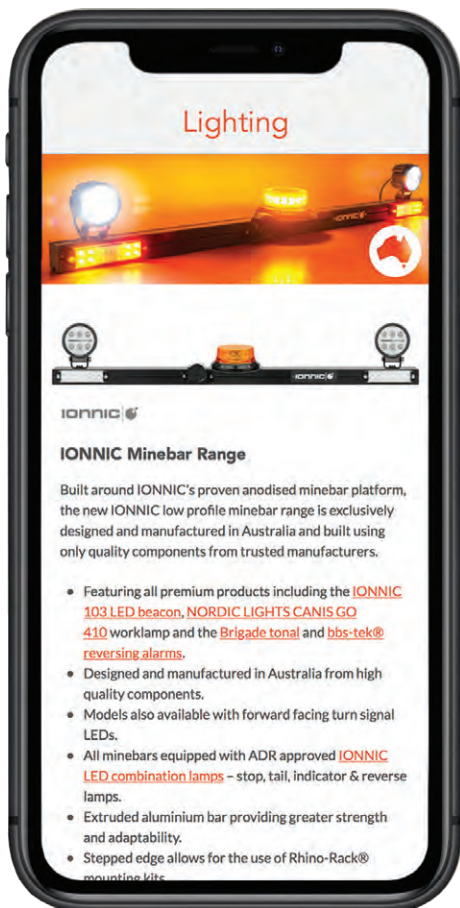

ionnic.com



Electrical



IONNIC Recessed E-Stop Kits

All new kits featuring Pressed Coated Steel or Nylon PA66 recessed housings.

- Protects and helps prevent accidental switch activation.
- Supplied with latching Telemecanique emergency stop switch.
- N/O or N/O & N/C contact block options.
- Round 'Emergency Stop' legend included.
- Available in kit and component form.
- Coated carbon steel or Nylon PA66.
- Multi-voltage.

[Learn More](#)

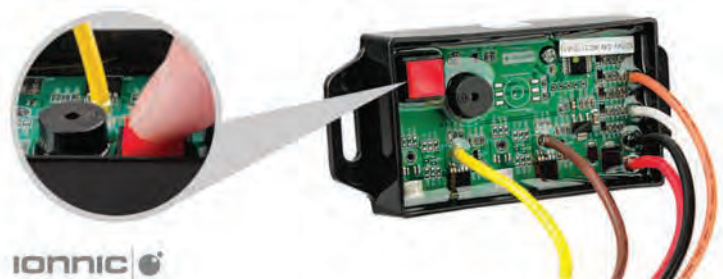

IONNIC Hand Brake Alarm Module – Now with Self-Learning Function

Designed to signal when hand brake is not engaged and vehicle door opens, this universal 2 stage alarm module can be adapted to suit any vehicle.

- Self learning function automatically detects vehicle triggers for quick and easy installation.
- Satisfies mine site requirements.
- 2 stage outputs.
- Compact easy installation.
- Suitable for positive and negatively switched vehicles/applications.
- Epoxy filled for enhanced moisture and vibration protection.
- 2 year warranty.

Environmentally Sealed

TE AMPSEAL 16



IP67 Made in North America

- 2 to 12 circuit configurations.
- Keyed to prevent mismatching.
- Integral retainer protects against accidental unlocking.
- Environmentally sealed – IP67, when installed to manufacturer's specifications.
- Chemical resistant.
- Available in assortment kits.
- Made in North America.

Housing : Thermoplastic
 Seals : Silicone
 Contact Size : 16
 Contact Rating : 13A @ 125°C
 Contact Material : Nickel-plated Copper Alloy
 Ingress Protection : IP67
 Operating Temperature : -40°C to 125°C

Plugs (Socket Housing)



776427-1 776429-1 776487-1 776433-1 776494-1 776437-1

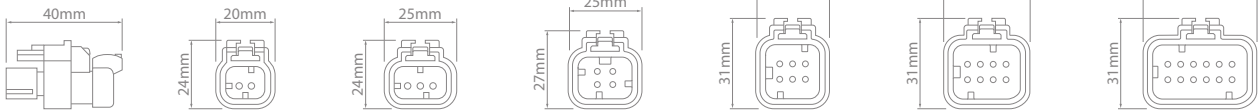

Receptacles (Pin Housing)



776428-1 776430-1 776488-1 776434-1 776495-1 776438-1

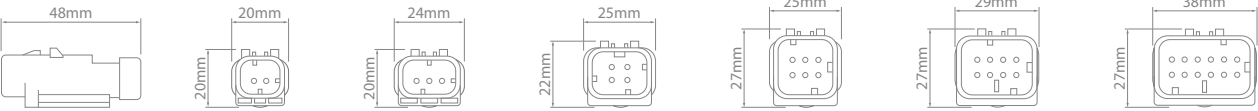

Receptacles (Pin Housing) Reverse Mount



1717672-1 1717673-1 1717674-1 1717675-1

TE AMPSEAL 16 – Connectors

	2 Cavity	3 Cavity	4 Cavity	6 Cavity	8 Cavity	12 Cavity
Plugs	776427-1	776429-1	776487-1	776433-1	776494-1 NEW	776437-1 NEW
Receptacles	776428-1	776430-1	776488-1	776434-1	776495-1 NEW	776438-1 NEW
Receptacles – Reverse Mount	1717672-1 NEW	1717673-1 NEW	1717674-1 NEW	1717675-1 NEW	—	—



Environmentally Sealed



TE AMPSEAL 16 – Contacts & Cavity Plug

Part No.	Pack Qty – 20	Pack Qty – 25	Pack Qty – 100	Type (Size 16)	Suits	Wire Size (mm ²)
0460-215-16141	—	•	•	Pin – Solid – Green Band	Receptacles	1.0 – 2.0
0462-209-16141	—	•	•	Socket – Solid – Green Band	Plugs	1.0 – 2.0
0460-202-16141	—	•	•	Pin – Solid	Receptacles	0.5 – 1.0
0462-201-16141	—	•	•	Socket – Solid	Plugs	0.5 – 1.0
1060-16-0122L	—	—	•	Pin – F-Crimp	Receptacles	0.8 – 2.0
1062-16-0122L	—	—	•	Socket – F-Crimp	Plugs	0.8 – 2.0
114017	•	—	•	Cavity Plug	Receptacles & Plugs	



DET16



HDT-48-00

TE AMPSEAL 16 – Tools

Part No.	Description	Crimp Range (AWG)
DET16	Ratcheting. 4 indent crimper	16
HDT-48-00	Ratcheting. 4 indent crimper	20, 16, 12



AMPSEAL16-KIT



NEW

Includes Crimp Tool

AMPSEAL16-KIT-1

NEW

TE AMPSEAL 16 – Assortment Kits

NEW

Part No.	Description	Receptacles:	Plugs:	Kit Contents
AMPSEAL16-KIT	110 Piece Solid contacts 20 pieces AMPSEAL 16 connector	2 x 776428-1 2 x 776430-1 2 x 776488-1 2 x 776434-1 1 x 776495-1 1 x 776438-1	2 x 776427-1 2 x 776429-1 2 x 776487-1 2 x 776433-1 1 x 776494-1 1 x 776437-1	Contacts & Cavity Plugs: 10 x Cavity Plugs (114017) 40 x Solid Pin – Green Band (0460-215-16141) 40 x Solid Socket – Green Band (0462-209-16141)
AMPSEAL16-KIT-1	111 Piece Solid contacts 20 pieces AMPSEAL 16 connector Crimping tool	2 x 776428-1 2 x 776430-1 2 x 776488-1 2 x 776434-1 1 x 776495-1 1 x 776438-1	2 x 776427-1 2 x 776429-1 2 x 776487-1 2 x 776433-1 1 x 776494-1 1 x 776437-1	Contacts & Cavity Plugs: 10 x Cavity Plugs (114017) 40 x Solid Pin – Green Band (0460-215-16141) 40 x Solid Socket – Green Band (0462-209-16141) 1 x Crimp Tool (DET16)



Environmentally Sealed

TE AMPSEAL

NEW



776164-1



776273-1

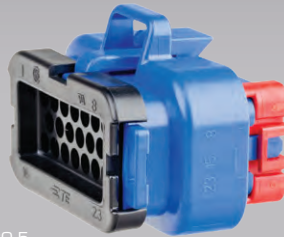

770680-5

- Wire to device connectors.
- Designed to withstand high-temperature environments.
- Accepts contact size 1.3 mm (up to 17A gold, up to 8A tin).
- 20-16 AWG (0.50-1.25 mm²).
- 8, 14, 23 and 35 cavity arrangements.
- Rectangular, thermoplastic housing.
- Integrated latch for mating.
- Integrated wedgelock confirms contact alignment and retention.
- Keyed according to colour to prevent mismatching.
- Environmentally sealed – IP6K9K, when installed to manufacturer's specifications.
- Made in North America.

Housing :	Thermoplastic
Seal :	Silicone
Wedgelock :	Thermoplastic
Contact Size :	1.3mm
Voltage :	250VAC
Contact Rating :	17A (gold), 8A (tin)
Shock :	50G
Insulation Resistance :	10 megohms
Ingress Protection :	IP6K9K
Operating Temperature :	-40°C to 105°C

IP6K9K Made in North America



776286-1



776273-5



770680-4



776164-2

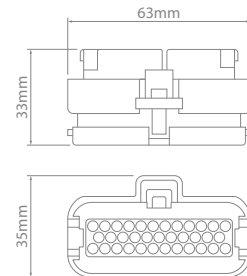
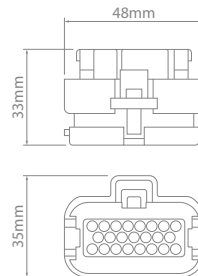
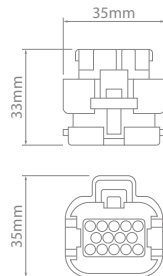
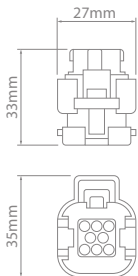

TE AMPSEAL – Connectors **NEW**

	8 Cavity	14 Cavity		23 Cavity	35 Cavity			
Colour	Black	Black	Blue	Black	Blue	Grey	Black	Natural
Part No.	776286-1	776273-1	776273-5	770680-1	770680-5	770680-4	776164-1	776164-2



Environmentally Sealed

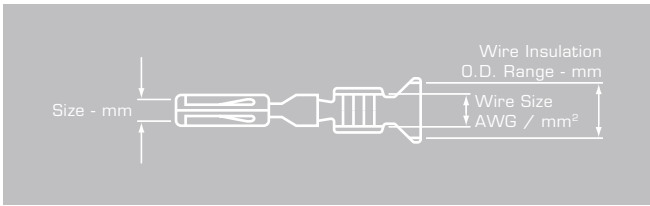

770854-1



770854-3

TE AMPSEAL – Contacts NEW

Pack Qty – 25	Plating	Size (mm)	Wire Size		Wire Insulation O.D. Range (mm)
			AWG	mm ²	
770854-1/25	Tin	1.3	20 – 16	0.5 – 1.5	1.7 – 2.7
770854-3/25	Gold	1.3	20 – 16	0.5 – 1.5	1.7 – 2.7



TE AMPSEAL – Cavity Plug NEW

Pack Qty – 10	Material
770678-1/10	Nylon



DTT-16-00



D7000

D7000

6 Removable Dies

<p>Die 1 14, 12AWG</p> <p>Die 3 18, 16, 14AWG</p> <p>Die 5 20, 18–16AWG</p>	<p>Die 2 12, 10AWG</p> <p>Die 4 20, 18, 16AWG</p> <p>Die 6 16, 14, 12AWG</p>
--	---

TE AMPSEAL – Crimping Tools

Part No.	Description	Crimp Range (AWG)
DTT-16-00 NEW	Ratcheting. 1 indent crimper “U” crimp	16 & 14
D7000	Ratcheting crimp tool set with 6 removable dies. 1 indent crimper “U” crimp	



Environmentally Sealed

M12 Network



- Wide range of M12 Network components.
- Environmentally sealed – IP67 or higher, when installed to manufacturer's specifications.
- Field Service Connectors feature built-in cable gland for strain relief and environmental sealing.
- Made in Europe.

IP67 Made in Europe

Current Rating : 4A
 Operating Temperature : -40°C to 75°C
 Ingress Protection : IP67



M12 Network – 5 Pin

Part No.	Description	Gender	Housing
RSC-2RKC57	T Piece	Male, Female, Female	Polyurethane
RSC-RSC-57	Joiner	Male to Male	Polyurethane
RKE57-TR2	Terminating Resistor	Female	Polyurethane
RSE57-TR2	Terminating Resistor	Male	Polyurethane
FK-FS4.5/M12	Bulkhead Connector	Male to Female	Metal
M12F5-ACODE	Field Service Connector	Female	Polyurethane
M12M5-ACODE	Field Service Connector	Male	Polyurethane
RSC-RKC5723-0.2M	Cable – 200mm	Male to Female	PVC
RSC-RKC5723-1M	Cable – 1m	Male to Female	PVC
RSC-RKC5723-2M	Cable – 2m	Male to Female	PVC
RSC-RKC5723-5M	Cable – 5m	Male to Female	PVC
RSC-RKC5723-10M	Cable – 10m	Male to Female	PVC
RKT5-228-2M	Cable – 2m	Female to tail	Polyurethane
RKT5-228-5M	Cable – 5m	Female to tail	Polyurethane
RKT5-228-10M	Cable – 10m	Female to tail	Polyurethane

Environmentally Sealed

- HPO01 features diagnostic LED and transparent housing.
- Environmentally sealed – IP65, when installed to manufacturer's specifications.
- Built-in cable gland for strain relief and environmental sealing.
- Made in North America.



HPO03



HPO01

Current Rating : 16A
Voltage : 250VAC max.
Contacts : Silver-plated Brass
Operating Temperature : -40°C to 90°C
Ingress Protection : HPO03 -25°C to 75°C IP65

Made in North America

IP65

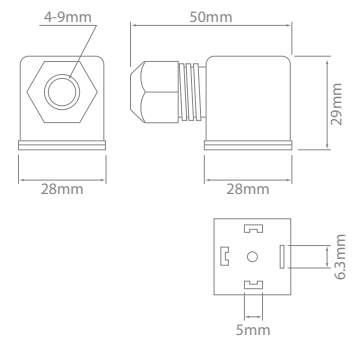
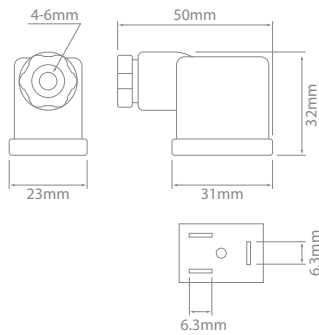
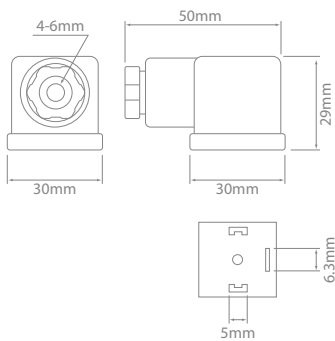

HPO01



HPO02



HPO03

DIN Connectors

Part No.	Terminals	Housing	Thread	Description
HPO01	3	Polypropylene	PG07	Diagnostic LED. 24V
HPO02	3	Polypropylene	PG07	
HPO03	4	Polyamide	PG11	



Environmentally Sealed

Schlemmer – Conduit Sealed

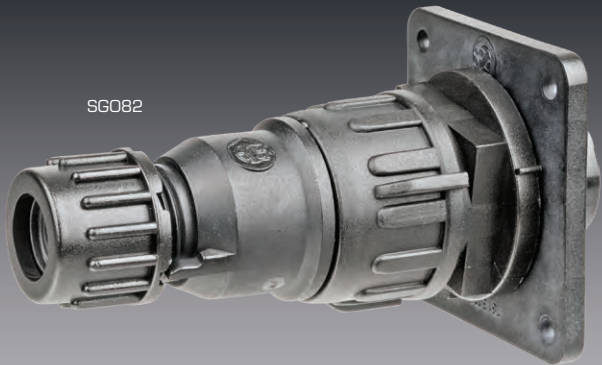

SG082



SG24902

Made in Europe

- Conduit Sealed connectors avoid ingress by sealing to the conduit.
- Environmentally sealed – IP67, when installed to manufacturer's specifications.
- Straight and 90° connectors available.
- Made in Europe.

Contacts :
Seal :
Housing :

Nickel-plated Brass
Neoprene
Polyamide 6

SG05
Cavity Configuration
5 x Ø 1.6mm Contacts



SG16
Cavity Configuration
12 x Ø 1.6mm Contacts
4 x Ø 3.5mm Contacts



SG21
Cavity Configuration
14 x Ø 1.6mm Contacts
7 x Ø 3.5mm Contacts

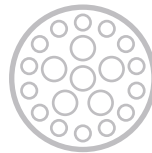

SG37
Cavity Configuration
37 x Ø 1.6mm Contacts

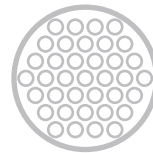

Schlemmer – In-line Connector Kits

Part No.	Conduit O.D. (mm)	Cavity Configuration	Total Circuits	Supplied With
SG05	12	5 x Ø 1.6mm	5	2 x Seals, 2 x Cap Nuts, 5 x 1.6mm Pins (7815018), 5 x 1.6mm Sockets (7814011)
SG16	25	12 x Ø 1.6mm & 4 x Ø 3.5mm	16	12 x 1.6mm Pins (7815018), 12 x 1.6mm Sockets (7814011), 4 x 3.5mm Pins (7815034), 4 x 3.5mm Sockets (7814038)
SG21	25	14 x Ø 1.6mm & 7 x Ø 3.5mm	21	14 x 1.6mm Pins (7815018), 14 x 1.6mm Sockets (7814011), 7 x 3.5mm Pins (7815034), 7 x 3.5mm Sockets (7814038)
SG37	25	37 x Ø 1.6mm	37	37 x 1.6mm Pins (7815018), 37 x 1.6mm Sockets (7814011)

Environmentally Sealed



SG272

Cavity Configuration



2 x Ø4mm Contacts



SG27902

Schlemmer – Solenoid Connector Kits – 2 Circuit

Part No.	Conduit O.D. (mm)	Cavity Configuration	Total Circuits	Thread Size	Orientation	Supplied With
SG272	8	2 x Ø4mm	2	M27 x 1.0	Straight	2 x 4mm Sockets (7702973)
SG24902	12	2 x Ø4mm	2	M24 x 1.0	90°	2 x 4mm Sockets (7702973)
SG27902	12	2 x Ø4mm	2	M27 x 1.0	90°	2 x 4mm Sockets (7702973)

Cavity Configuration

8 x Ø1.6mm Contacts



SG081



SG082

Cavity Configuration

7 x Ø1.6mm Contacts
1 x Ø3.5mm Contact



SG082

Schlemmer – Bulkhead Connector Kits – 8 Circuit

Part No.	Conduit O.D. (mm)	Cavity Configuration	Total Circuits	Supplied With
SG081	12	8 x Ø1.6mm	8	8 x 1.6mm Pins (7815018)
SG082	12	7 x Ø1.6mm & 1 x Ø3.5mm	8	7 x 1.6mm Pins (7815018), 7 x 1.6mm Sockets (7814011), 1 x 3.5mm Pin (7815034), 1 x 3.5mm Socket (7814038)



7702973



7814038



7814011



7815034



7702949



7815018

Schlemmer – Conduit Sealed Connectors – Contacts

Pack Qty – 10	Type	Contact Ø (mm)	Current Rating (A)	Cable Range (mm²)	Suits
7702973/10	Socket	4	25	2.5 – 6.0	SG272, SG24902, SG27902
7814038/10	Socket	3.5	25	2.5 – 6.0	SG16, SG21, SG082,
7814011/10	Socket	1.6	13	1.0 – 1.5	SG05, SG16, SG21, SG37, SG082
7815034/10	Pin	3.5	25	2.5 – 6.0	SG16, SG21
7702949/10	Pin	3.5	25	1.0 – 2.5	SG16, SG21
7815018/10	Pin	1.6	13	1.0 – 1.5	SG05, SG16, SG21, SG37, SG081, SG082



Environmentally Sealed



SQ409



SQ510

- Contact Sealed connectors utilise seals attached to the back of each contact to avoid ingress.
- Environmentally sealed – IP67, when installed to manufacturer’s specifications.
- Straight and 90° connectors available.
- Made in Europe

Made in Europe

Contacts :
Seal :
Housing :

Nickel-plated Brass
Neoprene
Polyamide 6

Cavity Configuration

00227700



4 x Ø5.2mm Cavities



SQ402

Cavity Configuration

SQ401, SQ409



4 x Ø6.7mm Cavities



SQ401



SQ409

Schlemmer – Contact Sealed Kits – 4 Circuit

Part No.	Conduit O.D. (mm)	Total Circuits	Cavity Configuration	Orientation	Supplied With
SQ402 NEW	10	4	4 x Ø5.2mm	Straight	5 x 5.2mm Pins (7814000), 5 x 5.2mm Seal (P-15324976), 2 x 5.2mm Cavity Plugs (P-12059168)
SQ401	10	4	4 x Ø6.7mm	Straight	4 x 6.7mm Sockets (7814125), 4 x 6.7mm Seal (15324983), 2 x 6.7mm Cavity Plugs (12010300)
SQ409	10	4	4 x Ø6.7mm	90°	4 x 6.7mm Sockets (7814125), 4 x 6.7mm Seal (15324983), 2 x 6.7mm Cavity Plugs (12010300)

Environmentally Sealed



Cavity Configuration



5 x Ø4mm Cavities

SQ510, SQ512

Schlemmer – Contact Sealed Kits – 5 Circuit

Part No.	Conduit O.D. (mm)	Total Circuits	Cavity Configuration	Orientation	Supplied With
SQ510	10	5	5 x Ø4mm	Straight	5 x 4mm Pins (7815045), 5 x 4mm Sockets (7814045), 10 x 4mm Seals (7814138), 4 x 4mm Cavity Plugs (7814135)
SQ512	12	5	5 x Ø4mm	Straight	5 x 4mm Pins (7815045), 5 x 4mm Sockets (7814045), 10 x 4mm Seal (7814138), 4 x 4mm Plugs (7814135)

Cavity Configuration



7 x Ø5.2mm Cavities

SQ701



SQ701



SQ801

Cavity Configuration



7 x Ø4mm Cavities
1 x Ø5.2mm Cavity

SQ801, SQ802



SQ802

Schlemmer – Contact Sealed Kits – 7 & 8 Circuit

Part No.	Conduit O.D. (mm)	Total Circuits	Cavity Configuration	Orientation	Supplied With
SQ701	13	7	7 x Ø5.2mm	90°	7 x 5.2mm Sockets, 7 x 5.2mm Seals (7814140), 7 x 5.2mm Cavity Plugs (7814136)
SQ801	12	8	7 x Ø4mm 1 x Ø5.2mm	Straight	7 x 4mm Sockets (7814050), 1 x 5.2mm Sockets (7814047), 8 x 5.2mm Seals (7814140), 4 x 5.2mm Cavity Plugs (7814136)
SQ802	12	8	7 x Ø4mm 1 x Ø5.2mm	90°	7 x 4mm Sockets (7814050), 1 x 5.2mm Sockets (7814047), 8 x 5.2mm Seals (7814140), 4 x 5.2mm Cavity Plugs (7814136)



Environmentally Sealed



Schlemmer – Contact Sealed – Contacts

Pack Qty – 10	Type	Contact Ø (mm)	Cable Range (mm ²)	Current Rating (A)	Suits
7814050/10	Socket	4.0	0.5 – 1.0	13	SQ510, SQ512, SQ801, SQ802
7815050/10	Pin	4.0	0.5 – 1.0	13	SQ510, SQ512
7814045/10	Socket	4.0	0.75 – 1.5	13	SQ510, SQ512, SQ801, SQ802
7815045/10	Pin	4.0	0.75 – 1.5	13	SQ510, SQ512
7814051/10	Socket	4.0	1.5 – 2.5	13	SQ510, SQ512, SQ801, SQ802
7814047/10	Socket	5.2	0.5 – 1.0	13	SQ801, SQ802
7814000/10	Pin	5.2	0.75 – 1.5	13	SQ701
7814048/10	Socket	5.2	1.5 – 2.5	13	SQ801, SQ802
7815048/10	Pin	5.2	1.5 – 2.5	13	
7814125/10	Socket	6.7	0.5 – 1.0	13	SQ401, SQ409
7814126/10	Socket	6.7	1.5 – 2.5	13	SQ401, SQ409



Schlemmer – Contact Sealed Connectors – Seals & Cavity Plugs

Pack Qty – 10	Description	Connector Cavity Ø (mm)	Cable O.D. Range (mm)	Colour	Suits
7814137/10	Seal	4.0	1.2 – 1.9	Red	SQ510, SQ512, SQ801, SQ802
7814138/10	Seal	4.0	1.86 – 2.4	Blue	SQ510, SQ512, SQ801, SQ802
7814140/10	Seal	5.2	1.2 – 2.1	Blue	SQ701, SQ801, SQ802
7814141/10	Seal	5.2	2.0 – 2.85	Burgundy	SQ801, SQ802
7814128/10	Seal	6.7	1.2 – 1.7	Burgundy	SQ401, SQ409
7814129/10	Seal	6.7	2.81 – 3.49	Grey	SQ401, SQ409
7814135/10	Cavity Plug	4.0	—	Green	SQ510, SQ512
7814136/10	Cavity Plug	5.2	—	Burgundy	SQ701, SQ801, SQ802
7814130/10	Cavity Plug	6.7	—	Green	SQ401, SQ409

Environmentally Sealed



7814145



7814147



7814146

Schlemmer – Tools – Crimpers

Part No.	Description	Crimp Range (mm ²)	Connector Cavity Ø (mm)
7814145	Ratcheting. Attaches seal & cable in one action	0.75–1.5	4
7814147	Ratcheting. Attaches seal & cable in one action	0.5–1.0 & 1.5–2.5	5.2
7814146	Ratcheting. Attaches seal & cable in one action	0.5–1.0 & 1.5–2.5	6.7



7704489



7704496



HT-7200

Schlemmer – Tools – Contact Removal

Part No.	Description	Conduit Sealed Contact Ø (mm)	Contact Sealed Connector Cavity Ø (mm)	Barrel Ø (mm)	
				Inside	Outside
7704489	Contact removal tool. Spring loaded	3.5	5.2	4.35	4.95
7704496	Contact removal tool. Spring loaded	1.6	4	3.00	3.23
HT-7200	Contact removal tool. Manual	1.6	4	2.92	3.23

