

Enclosures

Polypropylene 68

ABS/Thermoplastic 70

PVC 74

Die-cast 75

Pendant Control 76

Fuel Junction 78

Enclosures

Polypropylene

NEW

SBS003



SBZ003B

- Lightweight & compact.
- UV and ozone resistant.
- Flame retardant and halogen free.
- Robust polypropylene construction.
- Cable entries with self-sealing membranes.
- Moulded mounting points.
- Wide range of sizes.
- Available in grey or black.
- Most SBS series feature threaded cable entries for cable gland applications.
- Environmentally sealed.
- SBZ Series features firm but flexible construction.
- Made in Europe.



Made in Europe

Body :	Polypropylene
Sealing :	TPE
Ingress Protection :	SBZ IP55
	SBS IP66
Operating Temperature :	SBZ -30°C to 60°C
	SBS -30°C to 100°C



SBZ002B

IP55

Made in Europe

SBZ Series features firm but flexible construction



SBZ001

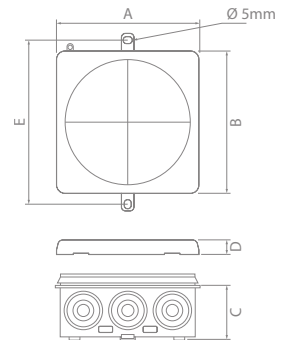

Lanyard prevents loss of enclosure cover

Polypropylene Enclosures – SBZ Series **NEW**

Part No.	Colour	No. of Cable Entries	Entry Orientation	A (mm)	B (mm)	C (mm)	D (mm)	E (mm)
SBZ001	Grey	10		86	44	33	8	94
SBZ001B	Black							
SBZ002	Grey	12		86	86	33	8	94
SBZ002B	Black							
SBZ003	Grey	14		125	86	33	8	133
SBZ003B	Black							



Polypropylene Enclosures – SBS Series NEW

Part No.	Colour	No. of Cable Entries	Entry Orientation	Cable Entries Sizes	A (mm)	B (mm)	C (mm)	D (mm)
SBS001	Grey	6		M20 (threaded)	85	49	32	19
SBS001B	Black							
SBS002	Grey	8		M20 (threaded)	85	85	32	19
SBS002B	Black							
SBS003	Grey	7		M20 (threaded)	95	95	41	19
SBS003B	Black							
SBS004	Grey	7		M25 (threaded)	110	110	47	19
SBS004B	Black							
SBS005	Grey	10		2 x M20, 3 x M20/M25, 5 x M25/M32	140	140	62	19
SBS005B	Black							



Polypropylene Enclosures – Accessories NEW

Part No.	Description	Pack Quantity	Suits
220S20	Blanking plug – M20 thread size	1	SBS Series
220S25	Blanking plug – M25 thread size	1	SBS Series
CG20	Cable gland, M20 thread size	1	SBS Series
CG20/10	Cable gland, M20 thread size	10	SBS Series
CG25	Cable gland, M25 thread size	1	SBS Series
CG25/10	Cable gland, M25 thread size	10	SBS Series
SBR001/10	Cable retainer ring	10	SBZ, SBS Series



Enclosures

ABS/Thermoplastic



SBA1212S



SBH2020

- Lightweight & compact.
- Corrosion resistant.
- Environmentally sealed.
- Hinged lid models feature pre-fitted offset mounting plate.
- All enclosures incorporate moulded mounting points, excluding Hinged lid models.
- Ideal for terminal boxes, control boxes, power distribution panels and instrument containers.
- Supplied with sealing gasket.

Hinge & Latch :

Operating Temperature :

Stainless Steel

-40°C to 120°C

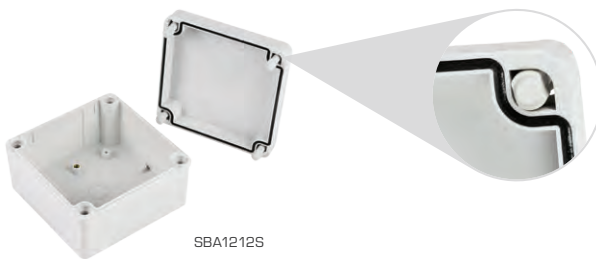

SBA1212S

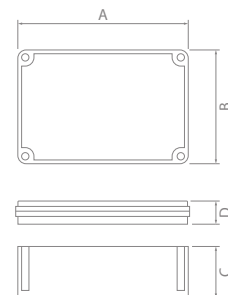

ABS Enclosures – SBA Series

Part No.	A (mm)	B (mm)	C (mm)	D (mm)
SBA0712	125	75	50	25
SBA0811	110	80	50	20
SBA1010	100	100	55	20
SBA1212	125	125	80	20
SBA1212S	125	125	55	20
SBA1217	175	125	50	25
SBA1525-1	250	150	80	50

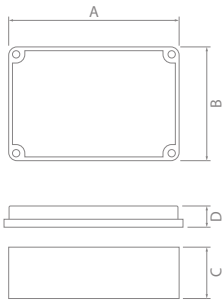

ABS Enclosures – SBB Series

Part No.	A (mm)	B (mm)	C (mm)	D (mm)
SBB0812	80	120	40	14
SBB1010	100	100	40	14
SBB1115	150	110	49	25
SBB1924	240	190	70	26
SBB2230	300	220	76	50

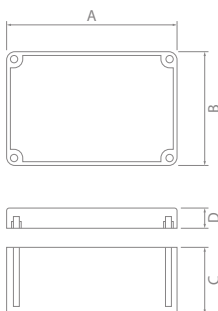

ABS Enclosures – H Series

Part No.	A (mm)	B (mm)	C (mm)	D (mm)
H0300	60	65	25	15
H0301	75	105	25	15
H0302	80	85	40	15
H0304	85	125	40	15
H0306	85	165	40	15
H0308	125	165	60	15
H0310	146	186	60	15



Enclosures

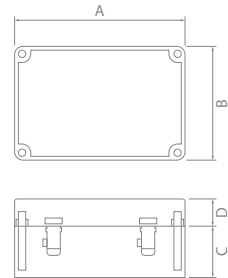

ABS Enclosures – Hinged Lid

Part No.	A (mm)	B (mm)	C (mm)	D (mm)
SBH1212S	125	125	55	20
SBH2020	200	200	120	20
SBH2819-1	280	190	100	80

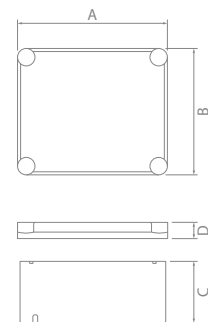

Thermoplastic Enclosures – 50 Series

Part No.	A (mm)	B (mm)	C (mm)	D (mm)
50856	113	113	40	17
50860	113	79	40	17
50861	113	113	70	17
50862	119	161	56	17
50864	170	145	69	17
50866	230	180	64	17
50868	322	250	113	17
50870	170	145	70	88
50872	230	180	72	88

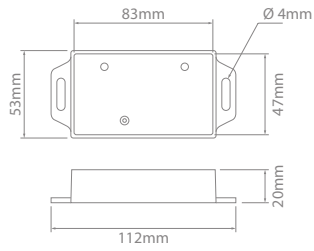

SIPRO1

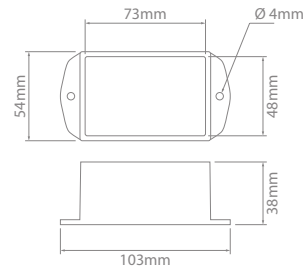

SIPRO2

IONNIC Potting Box

Part No.	Description	Profile
SIPRO1	Open top enclosure ideal for use with epoxy resin	Low
SIPRO2	Open top enclosure ideal for use with epoxy resin	High



Enclosures

PVC



265/4



265/1

- Solid & lightweight enclosures.
- Environmentally sealed – IP56.
- Ideal for general purpose applications.
- Supplied with sealing gasket.

IP56

Body : Polyvinyl Chloride
 Ingress Protection : IP56
 Operating Temperature : -20°C to 60°C



265/4

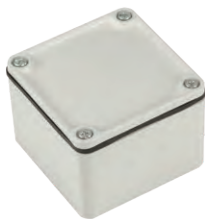

265/1

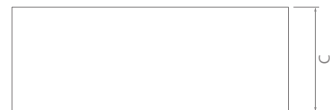
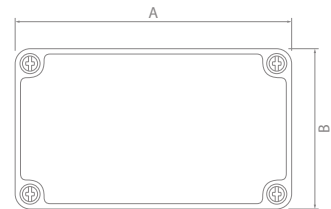

PVC Enclosures

Part No.	A (mm)	B (mm)	C (mm)	D (mm)	Wall Thickness (mm)
265/1	77	77	48	5	2.8
265/3	108	108	70	6	4.1
265/4	162	108	70	9	4.1
265/5	210	106	70	9	4.1
265/7	300	200	140	10	4.7

- Industrial grade heavy duty die-cast.
- Flanged base for easy mounting.
- High impact, corrosion resistant.
- Wide range of sizes.
- Environmentally sealed – IP66.
- Ideal for mining, industrial, agricultural and marine use.
- Supplied with sealing gasket.*

H0420

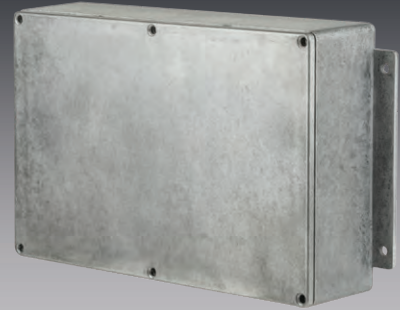

H0429

H0423

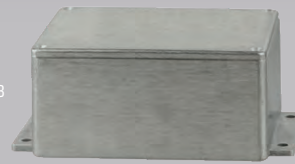

Body : Die-cast Aluminium
 Ingress Protection : IP66
 Operating Temperature : -40°C to 100°C

IP66

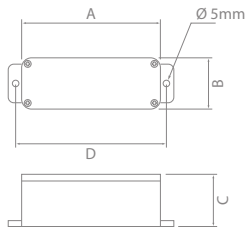

Fig 1



H0420



H1590

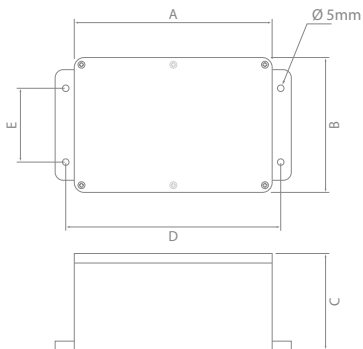

Fig 2



H0429

Die-cast Enclosures

Part No.	A (mm)	B (mm)	C (mm)	D (mm)	E (mm)	Wall Thickness (mm)	Fig
H0420	89	53	30	100	—	1.4	1
H0421	114	64	30	127	30	1.4	2
H0422	114	64	55	127	30	1.4	2
H0423	114	90	55	127	50	1.8	2
H0424	120	100	35	137	60	1.8	2
H0427	171	121	55	189	80	1.8	2
H1590*	197	120	37	202	92	2.5	2
H0429	222	146	55	238	98	2.2	2

* Powder coated black. Not supplied with sealing gasket. Not IP66.





- Configurable to personal requirements.
- Engraved face plate available on request.
- Wide range of toggle switches available to integrate.

Example shown with toggle switches installed

Body :

Polyurethane

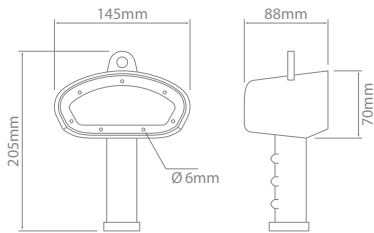

HC1



FP



FP2



FP3



CG16SR

Pendant Control

Part No.	Description
HC1	Hand controller body
FP	Face plate – black
FP2	Face plate – 2 hole. 8mm switch hole
FP3	Face plate – 3 hole. 8mm switch hole
CG16SR	IP68 strain relief adaptor, when installed to manufacturer's specifications. 4mm to 8mm

Requires 7 x 8mm screws for face plate.
Engraved face plates available on request.

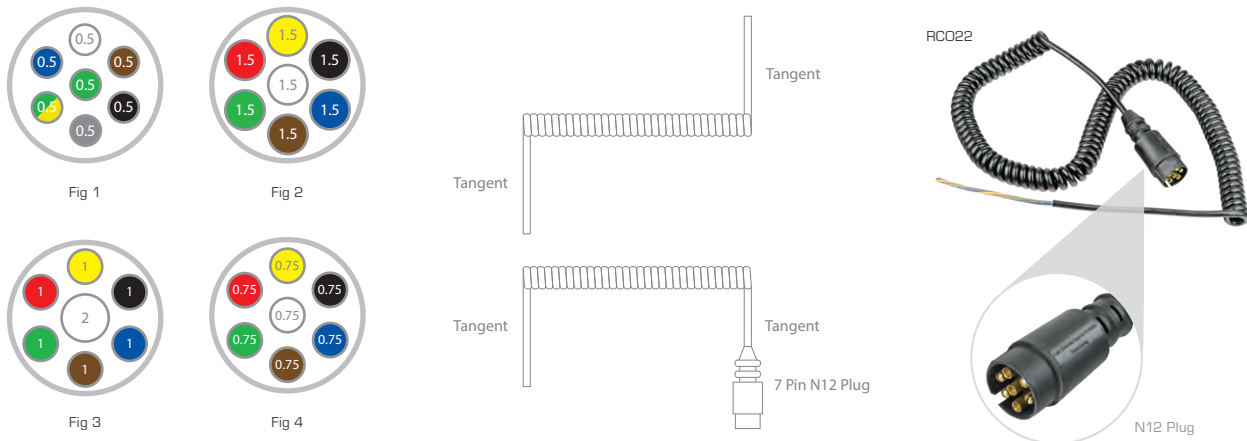

Compatible Suzi Coils – 7 Core

Part No.	Cores - Qty x mm ²	Tails	Working Length (m)	Fig
RC013	7 x 0.5	Tangent	3	1
RC014	7 x 0.5	Tangent	2	1
RC031	7 x 1.5	Tangent	8	2
RC032	1 x 2, 6 x 1	Tangent	3	3
RC022	7 x 0.75	Tangent with 1 x N12 plug	7.5	4



Other Toggle Switch accessories available, visit ionnic.com to find out more.

Compatible Toggle Switches

Part No.	Action	Terminal Style	Maximum Load @ 24V (A)	
TS403A	OFF	Screw	15	
TS403E	ON	Blade	15	
MTS403		Screw	20	
TS508A	OFF	Screw	15	
MTS508	Mom.ON	Screw	15	
TS401A	ON	Screw	15	
TS401E	ON	Blade	15	
MTS401		Screw	20	
TS101A	ON	Screw	15	
TS101E	OFF	Blade	15	
MTS101	ON	Screw	20	
TS301A	Mom.ON	Screw	15	
TS301E	OFF	Blade	15	
MTS301	Mom.ON	Screw	15	

Enclosures

Fuel Junction

- Environmentally sealed – IP67.
- Integrated Threadconnect fitting.



IP67

Body : Polyoxymethylene
 Seal : Perbunane
 Ingress Protection : IP67
 Operating Temperature : -25°C to 80°C

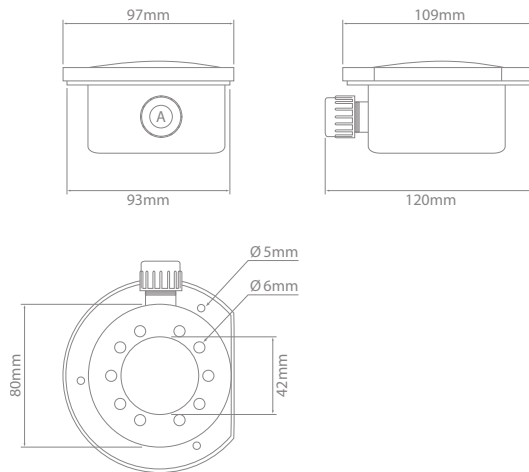

Fuel Junction Enclosure Kit

Part No.	NW (A)	NC (A)
ST01	10	12

Kit contains: 1 x Housing, 1 x Lid Seal, 1 x Lid, 1 x Cap Nut, 1 x Conical Seal